

RoHS Compliant

REVISIONS			
REV.	DESCRIPTION	DATE	DESIGN

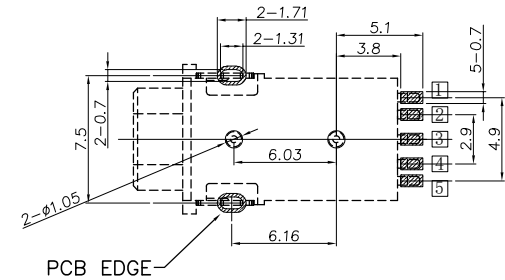
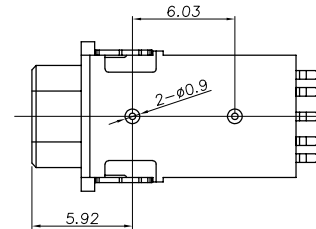
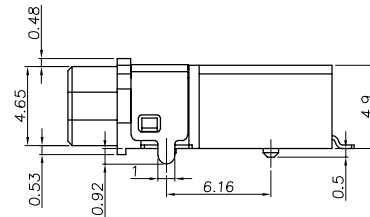
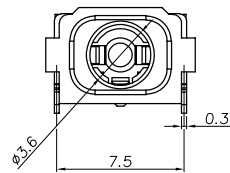
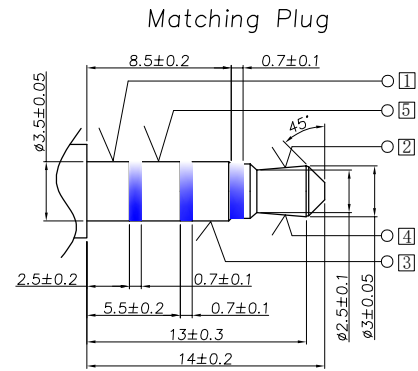
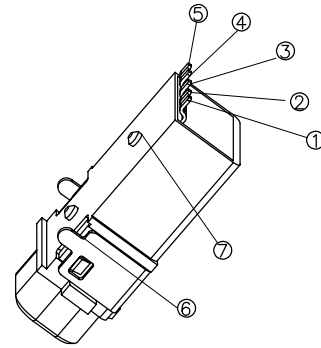
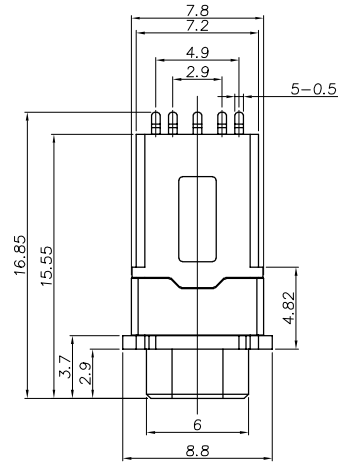

RECOMMENDED P. C. B LAYOUT
TOP VIEW (TOLERANCE: ±0.05)

SPECIFICATION:

- Electrical characteristics
 - 1-1. Current rating: DC 0.5A max.
 - 1-2. Voltage rating: DC 30V.
 - 1-3. Contact resistance: 50mΩ max
 - 1-4. Insulation resistance: 1000MΩ min. at 500V DC.
 - 1-5. Withstanding voltage: 500V AC for 1 minute.
- Mechanical characteristics
 - 2-1. Life test: 5000 cycles min,
 - 2-2. Mating force: 3~30N, Unmating force: 3~30N.
- Temperature range: -40° C~+80° C
- Dustproof and waterproof grade: IP67

7	塑胶外壳	1	PA9T	Black
6	插脚	1	SUS304-1/2H 0.3t	镀锌
5	5#脚	1	C5210-EH T=0.2	全区镀金1"u"
4	4#脚	1	C5210-EH T=0.2	全区镀金1"u"
3	3#脚	1	C5210-EH T=0.2	全区镀金1"u"
2	2#脚	1	C5210-EH T=0.2	全区镀金1"u"
1	1#脚	1	C5210-EH T=0.2	全区镀金1"u"
NO.	DESCRIPTION	QTY	MATERIAL	REMARK

Bestcreate Technology Limited

TOLERANCES UNLESS OTHERWISE SPECIFIED:

X.	± 0.20	X.'	± 3'
.X	± 0.15	.X'	± 2'
.XX	± 0.10	.XX'	± 1'

DESIGN: I. L DATE: 2017. 3. 1

CHECKED: C. W DATE: 2017. 3. 1

APPROVED: C. W DATE: 2017. 3. 1

TITLE: IP67 WATERPROOF PHONE JACK CONNECTOR

MATERIAL: FINSH: PART NO: PJ350-05-W002-V1 SIZE: A4

DWG NO: PJ350-05-W002-V1

REV: A UNIT: mm SCALE: 1=1 QUALITY SYMBOLS

Website: www.bsc-elec.com Email: bestcreate@bsc-elec.com