

RoHS Compliant

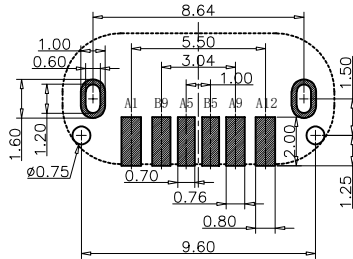

RECOMMEND P.C.B LAYOUT (COMPONENT SIDE)
TOLERANCE FOR PCB LAYOUT IS ±0.05

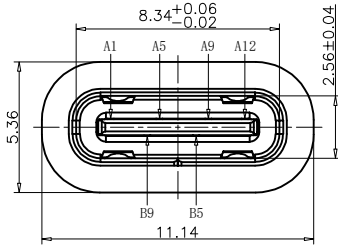
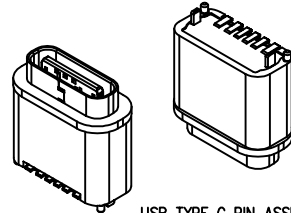
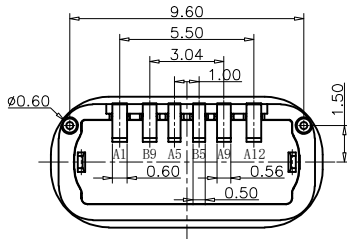
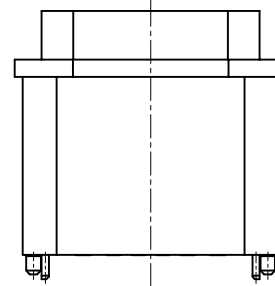
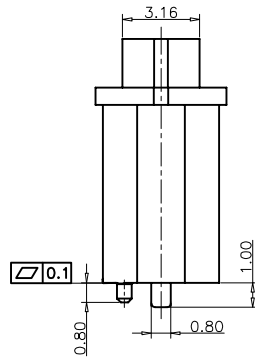
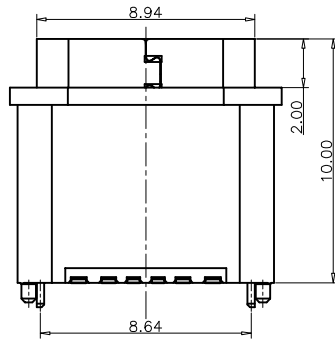

USB TYPE C PIN ASSIGNMENTS

PIN NUMBER	SIGNAL NAME	PIN NUMBER	SIGNAL NAME
A1	GND	B9	VBUS
A5	CC1	B5	CC2
A9	VBUS		
A12	GND		

REVISIONS			
REV.	DESCRIPTION	DATE	DESIGN

NOTES:

SPECIFICATION:

- CURRENT RATING: 3.0 A
- VOLTAGE RATING: 5 V
- VBUS & GND PINS AND OTHER PINS: 40mΩ/PIN MAX
SHIELD: 50mΩ/MAX
LLCR MAX. CHANGE OF ALL PINS: 10Qm
- INSULATION RESISTANCE: 100MΩ MIN
- DIELECTRIC WITHSTAND VOLTAGE, AC 100V FOR 1MINUTE
- INSERTION FORCE: 0.5~2.0kgf
- UNMATING FORCE: 0.6-2.04kgf
- DURABILITY: 10000 CYCLES
- OPERATING TEMPERATURE: -20°C~+85°C
- THE PEAK TEMPERATURE ON THE BOARD SHALL BE MAINTAINED FOR 10 SECONDS AT 210-230°C
- WATERPROOF: IP-X7.

PART NO. INFORMATION

U06-C F X X 5 R - W126 - V5

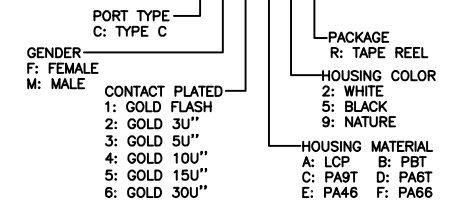

TABLE:

NO	PART	Q'TY	Material
1	SHELL	1	STAINLESS STEEL, NI PLATED
2	CONTACT	6	COPPER STEEL, TIN/AU/NI PLATED
3	1MD HOUSING	1	HIGH TEMPERATURE RESISTANT PLASTIC BLACK UL94 V-0
4	2MD HOUSING	1	HIGH TEMPERATURE RESISTANT PLASTIC BLACK UL94 V-0

Bestcreate Technology Limited

TOLERANCES UNLESS OTHERWISE SPECIFIED:

.X	± 0.30	.X"	± 5"
.XX	± 0.20	.X'"	± 2'"
.XXX	± 0.15	.XX'"	± 1'"

Website: www.bsc-elec.com
Email: bestcreate@bsc-elec.com

DESIGN: I. L
DATE:
CHECKED: C. W
DATE:
APPROVED: C. W
DATE:

TITLE: IPX7 WATERPROOF 6P USB C FEMALE CONNECTOR VERTICAL SMT, H=10.0MM
MATERIAL: PART NO: U06-CFXX5R-W126-V5 SIZE: A4
FINISH: DWG NO: U06-CFXX5R-W126-V5 1 OF 1

REV: A UNIT mm SCALE 1=1 QUALITY SYMBOLS